







ST 010 106 2705



- 200mm projection
- fixed spout
- rectangular spray pattern with 40 individual jets
- height of mixer 343 mm
- height up to aerator 329 mm
- hole diameter valve 32 mm
- hole diameter spout 35 mm
- rosette 60 x 47 mm
- 2x screw-in M 10 x 1 pressure hose, leak-tested
- max. flow 4 l/min
- lead-free
- This product can help a building meet the requirements of Green Building Rating Systems, e.g. LEED®, BREEAM®, DGNB

	Dark Chrome	ST 010 106 2705-19
	Chrome	ST 010 106 2705-00
	Brushed Platinum	ST 010 106 2705-06
	Brushed Champagne (22kt Gold)	ST 010 106 2705-46
	Champagne (22kt Gold)	ST 010 106 2705-47
	Brushed Dark Platinum	ST 010 106 2705-99

**Individual components of this set**

You need the following components for this set

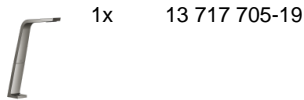

1x 13 717 705-19

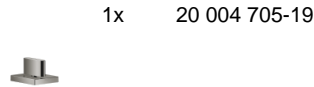

1x 20 004 705-19

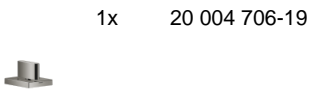

1x 20 004 706-19



## CL.1 Three-hole basin mixer without pop-up waste - Dark Chrome

---







CL.1

ST 010 106 2705

ST 010 106 2705



- 200mm projection
- fixed spout
- rectangular spray pattern with 40 individual jets
- height of mixer 343 mm
- height up to aerator 329 mm
- hole diameter 35 mm
- max. flow 4 l/min
- 1/2" connection
- 2x screw-in M 10 x 1 pressure hose, leak-tested
- lead-free
- This product can help a building meet the requirements of Green Building Rating Systems, e.g. LEED®, BREEAM®, DGNB

	Dark Chrome	13 717 705-19
	Chrome	13 717 705-00
	Brushed Platinum	13 717 705-06
	Brushed Champagne (22kt Gold)	13 717 705-46
	Champagne (22kt Gold)	13 717 705-47
	Brushed Dark Platinum	13 717 705-99

ST 010 106 2705

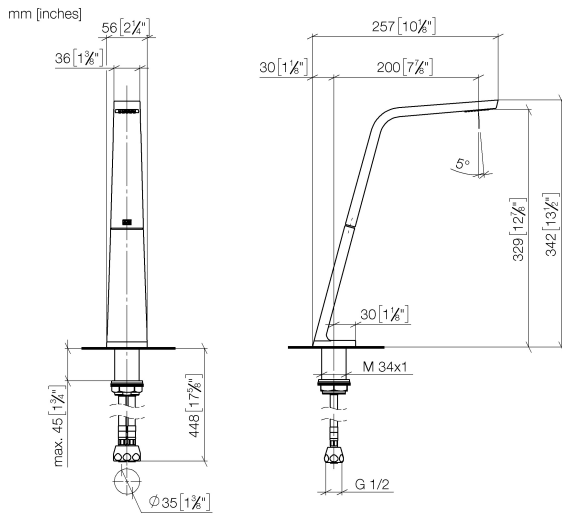

**Flow rate chart**

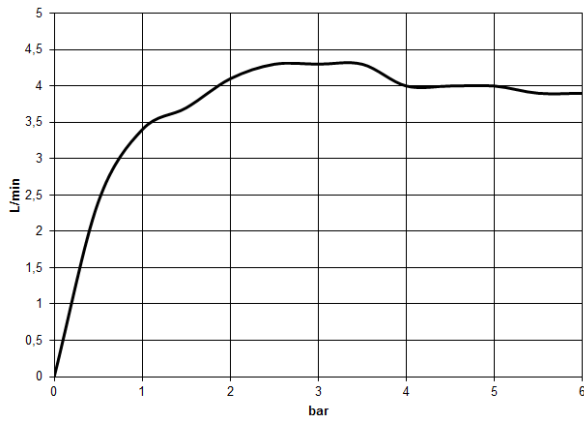

**Codes & Standards**

ASME  
A112.18.1/CSA  
B125.1

California Energy  
Commission  
(CEC)

NSF/ANSI 372

NSF/ANSI/CAN  
61

**Certificates**

GDV\_0400279. IAPMO\_N-4976. IAPMO\_6397.



## CL.1 Three-hole basin mixer without pop-up waste - Dark Chrome

---

CL.1

ST 010 106 2705





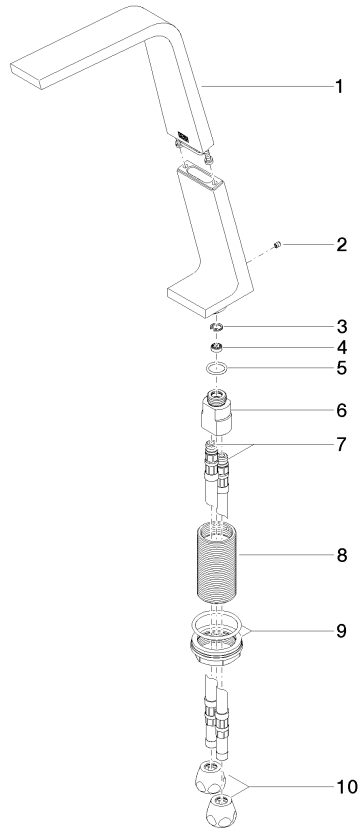

ST 010 106 2705

Parts for other finishes can be found here: [Chrome](#)



- hole diameter 32 mm
- rosette 60 x 47 mm
- with cold marking



	Dark Chrome	20 004 705-19
	Chrome	20 004 705-00
	Brushed Platinum	20 004 705-06
	Brushed Champagne (22kt Gold)	20 004 705-46
	Champagne (22kt Gold)	20 004 705-47
	Brushed Dark Platinum	20 004 705-99



## CL.1 Three-hole basin mixer without pop-up waste - Dark Chrome

---

CL.1

ST 010 106 2705

ST 010 106 2705

mm [inches]

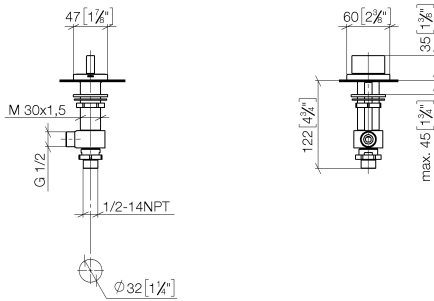

**Flow rate chart**



**Codes & Standards**

ADA	ASME A112.18.1/CSA B125.1	NSF/ANSI 372	NSF/ANSI/CAN 61
-----	---------------------------------	--------------	--------------------

**Certificates**

IAPMO_N-4976.	LGA_28687.	IAPMO_6397.	WRAS_240202020.
---------------	------------	-------------	-----------------





## CL.1 Three-hole basin mixer without pop-up waste - Dark Chrome

---

CL.1

ST 010 106 2705

ST 010 106 2705

Parts for other finishes can be found here: [Chrome](#)

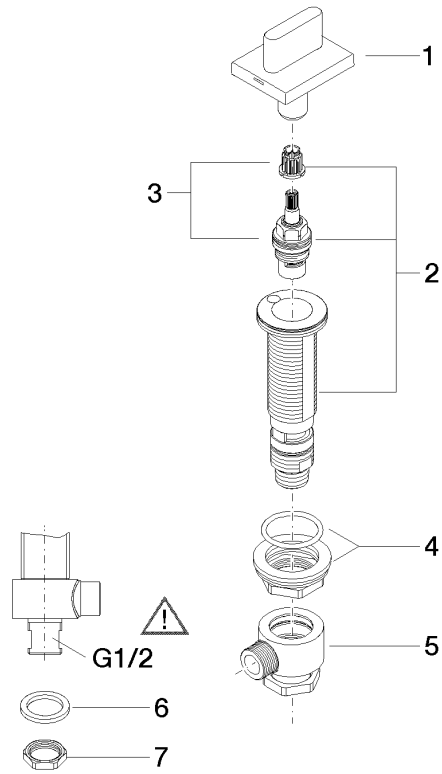

**Spare parts list**

No.	Item Number	Name	Quantity used	Delivery time
1	90 20 70 051 06-19	handle ( cold )	1	20
2	04 17 11 058 53 90	side panel	1	2
3	90 90 03 153 00 90	top	1	2
4	04 23 10 032 78 90	fixing set	1	2
5	04 17 11 023 10 90	distributor	1	2
6	90 23 30 040 00-19	threaded connector	1	-
Spare part can no longer be ordered, please order the replacement item				
7	09 30 11 059 90	disc	1	2
8	09 23 10 012 90	nut	1	2







**CL.1 Three-hole basin mixer without pop-up waste - Dark Chrome**

CL.1

ST 010 106 2705

- hole diameter 32 mm
- rosette 60 x 47 mm
- with hot marking



	Dark Chrome	20 004 706-19
	Chrome	20 004 706-00
	Brushed Platinum	20 004 706-06
	Brushed Champagne (22kt Gold)	20 004 706-46
	Champagne (22kt Gold)	20 004 706-47
	Brushed Dark Platinum	20 004 706-99



## CL.1 Three-hole basin mixer without pop-up waste - Dark Chrome

---

CL.1

ST 010 106 2705

ST 010 106 2705

mm [inches]

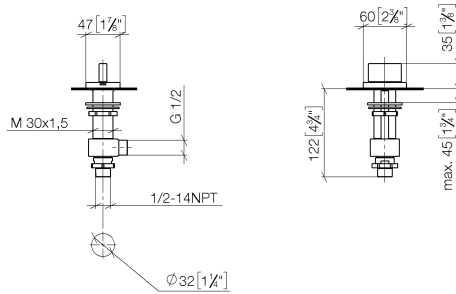

**Flow rate chart**

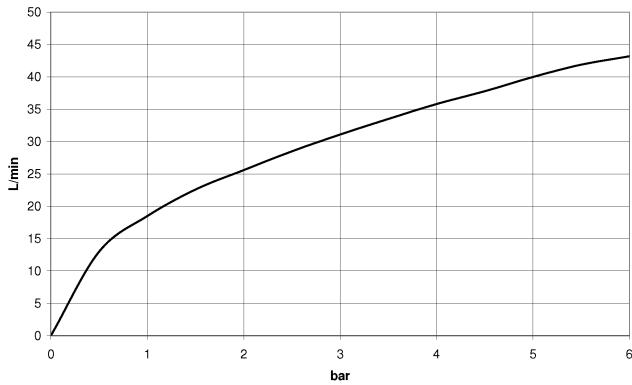

**Codes & Standards**

ADA	ASME A112.18.1/CSA B125.1	NSF/ANSI 372	NSF/ANSI/CAN 61
-----	---------------------------------	--------------	--------------------

**Certificates**

IAPMO\_N-4976.    LGA\_28687.    IAPMO\_6397.    WRAS\_240202020.



ST 010 106 2705

Parts for other finishes can be found here: [Chrome](#)

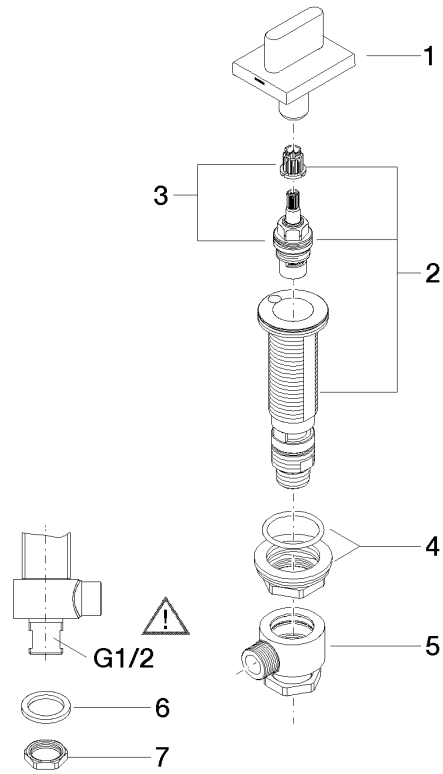

### Spare parts list

No.	Item Number	Name	Quantity used	Delivery time
1	90 20 70 051 07-19	handle ( hot )	1	20
2	04 17 11 058 52 90	side panel	1	2
3	90 90 03 152 00 90	top	1	2
4	04 23 10 032 78 90	fixing set	1	2
5	04 17 11 023 10 90	distributor	1	2
6	90 23 30 040 00-19	threaded connector	1	-
Spare part can no longer be ordered, please order the replacement item				
7	09 30 11 059 90	disc	1	2
8	09 23 10 012 90	nut	1	2